

Welch Allyn® OAE Hearing Screener



Directions for use

© 2021 Welch Allyn. All rights are reserved. To support the intended use of the product described in this publication, the purchaser of the product is permitted to copy this publication, for internal distribution only, from the media provided by Welch Allyn. No other use, reproduction, or distribution of this publication, or any part of it, is permitted without written permission from Welch Allyn. Welch Allyn assumes no responsibility for any injury to anyone, or for any illegal or improper use of the product, that may result from failure to use this product in accordance with the instructions, cautions, warnings, or statement of intended use published in this manual.

For patent information, please visit www.welchallyn.com/patents.

For information about any Welch Allyn product, contact Welch Allyn Technical Support: www.welchallyn.com/about/company/locations.htm.

GSI is an ISO 13485 certified corporation.

GSI 8108699

DIR 80022349 Ver. E

Revision date: 2021-02

This manual applies to

REF

 901031 OAE HEARING SCREENER.

Distributed by Welch Allyn, Inc.
4341 State Street Road
Skaneateles Falls, NY 13153-0220 USA



Grason-Stadler
10395 West 70th Street
Eden Prairie, MN 55344 USA

www.welchallyn.com

EC	REP
----	-----

Grason-Stadler
c/o DGS Diagnostics A/S
Audiometer Alle 1,
5500 Middelfart
Denmark



0123

WelchAllyn®

Advancing Frontline Care™

Contents

Symbols and indicators	1
About warnings and cautions	3
Warnings and cautions	3
Introduction	7
OAE functionality	8
Distortion product otoacoustic emissions (models 39500 and 39500-NP)	9
Transient evoked otoacoustic emissions (models 39500-TE and 39500-TE-NP)	9
Frequency Range tested	9
Results storage and reporting	9
Sensitivity and specificity	9
Setup	11
Unpack the system	11
Cradle	12
Charge the battery	12
Install the probe	13
Attach the probe tube	14
Eartips	14
Probe holder	15
Clock settings	16
Device overview	19
Control panel	19
Access menus	19
Device settings	20
Wireless device pairing	20
Clear test results	21
Minimum amplitude	22
Change the language	22
Reset to default	22
Operating instructions	23
Turn on the screener	23
Automatic shutdown interval	23
Main menu	24
Select the test protocol	25
Prepare the patient for testing	25
Start a test	25
AutoStart probe check	25

Test results	27
Test phase	27
Graph styles	27
Test techniques	29
Noise sources	29
View results	30
Manage results	31
Results storage and reporting	31
Save/Store test results mode	31
Delete test results	33
Connect the screener to a computer	33
Connect the screener cradle to a computer	34
Connect the screener to a computer using wireless	34
Pair the screener and wireless device	34
Print to a thermal printer	35
Understand printed results	37
DPOAE printout	37
TEOAE printout	37
Rounding results	38
Maintenance	39
General maintenance	39
Clean and disinfect	39
Calibrate the screener	40
Replace the probe tube	40
Repairs	41
Troubleshooting	43
Status/Error messages	46
Standards and compliance	47
General compliance and standards	47
EMC compliance	48
Warranty	53
Appendices	55
Appendix A: Specifications	55
Appendix B: Flowchart – Measurement	58
Appendix C: Test sequence	59
Appendix D: Pass/Refer criteria	61
Appendix E: Configurations and test protocols	63
Appendix F: Approved accessories	64
Appendix G: General radio compliance	64

Symbols and indicators

Documentation symbols























WARNING The warning statements in this manual identify conditions or practices that could lead to illness, injury, or death.



Caution The caution statements in this manual identify conditions or practices that could result in damage to the equipment or other property, or loss of data. This definition applies to both yellow and black and white symbols.

Regulatory symbols

Symbol	Description	Symbol	Description
	Serial number		Transport and storage temperature range
	Date of manufacture		Keep dry
	Manufacturer		B Patient Applied Part According to IEC60601-1
	Return to Authorized Representative, special disposal required		Consult directions for use (DFU). A copy of the DFU is available on this website. A printed copy of the DFU can be ordered from Welch Allyn for delivery within 7 calendar days.
	Reorder number		Single use, do not reuse

Symbol	Description	Symbol	Description
	Regulatory Product Identifier (RPI) number		Not made with natural rubber latex
	Global Trade Item Number		Direct current (DC)
	Federal Communications Commission mark		Non-ionizing electromagnetic radiation
	UL Testing Services, Inc., with respect to electric shock, fire, and mechanical hazards only, in accordance with UL 60601-1.		For Use by or on the order of a licensed medical professional
	Recycle - Taiwan		Recycle Lithium ion battery
2INRI9/66	Designates the battery type. 2 = 2 cells in series; I = Lithium ion; N = Nickel; R = Cylinder; 19 = 19mm; 66 = 66mm		China RoHS

Indicator lights (LEDs)

Message	Definition
NOISE/Amber	The indicator labeled 'NOISE' displays an amber light when the noise level measured during the test exceeds a nominal threshold. It also is used to indicate some error conditions and when the outcome of test is REFER, NOISY, or NO SEAL.
TEST/Yellow	The indicator labeled 'TEST' displays a yellow light when the selected test is being performed. A steady yellow light indicates that a test is in progress.
READY/Green	The indicator labeled 'READY' displays a steady green light indicating that no test is being administered and that the screener is ready to be used for testing.
CHARGE/Blue	The indicator labeled 'CHARGE' displays a steady blue light when the battery is charging. The intensity of the blue light indicates the progress of the battery charging.

About warnings and cautions

Warning and caution statements can appear on the Welch Allyn OAE screener (screener), on the packaging, on the shipping container, or in this directions for use.

The screener is safe for patients and clinicians when used in accordance with the instructions and the warning and caution statements presented in this directions for use.

Before using the device, you must familiarize yourself with all warnings and cautions, with the steps to power up the screener, and with the sections of this directions for use that pertain to your use of the screener. In addition to reviewing the general warnings and cautions presented in the next section, you must also review the more specific warnings and cautions that appear throughout the manual in conjunction with setup/startup, screener operation, patient monitoring, and maintenance tasks.

Warnings and cautions



WARNING Safety risk. Use only the provided power supply to charge the screener. Injury to personnel or damage to the screener can result when a three-prong to two-prong adaptor is connected between the screener power supply and a mains outlet.



WARNING Safety risk. Only qualified Welch Allyn service representatives should modify the screener. Improper modifications could be hazardous to patients and personnel.



WARNING Safety risk. Any program aimed at obtaining reliable measurements of otoacoustic emissions should be staffed and supervised by appropriately trained individuals.



WARNING Electric shock hazard. This product should not be used in the presence of fluid that can come into contact with any of the electronic components or wiring. Should the user suspect fluids have contacted the system components or accessories, the unit should not be used until deemed safe by a Welch Allyn certified service technician.



WARNING Fire and explosion hazard. Do not use the screener in the presence of flammable gaseous mixtures. There is the possibility of explosions or fire when used in close proximity to flammable anesthetic gases.



WARNING Fire and explosion hazard. Do not use the screener in a highly oxygen-enriched environment, such as a hyperbaric chamber, oxygen tent, and the like.



WARNING Electric shock hazard. Do not touch the contacts on the bottom of the screener and the patient at the same time.



WARNING Safety hazard. This screener contains a rechargeable lithium-ion battery. The battery is not user-replaceable and must be returned to an authorized Welch Allyn service location for repair.



WARNING Fire and explosion hazard. Do not operate the screener in the presence of a flammable anesthetic mixture with air, oxygen, or nitrous oxide; in oxygen-enriched environments; or in any other potentially explosive environment.



WARNING Safety risk. When handling and storing lithium-ion batteries, avoid mechanical or electrical abuse. Batteries may explode or cause burns if disassembled, crushed, or exposed to fire or high temperatures. Do not short or install the battery with incorrect polarity.



WARNING Inaccurate measurement risk. Use only the disposable eartips designed for use with the screener.



WARNING Patient injury risk. Never insert the probe tube into the ear canal without a properly attached eartip.



WARNING Cross-contamination and nosocomial infection risk. The eartips are disposable and for single patient use only. Do not clean and reuse eartips.



CAUTION The screener has been verified by an independent laboratory to conform to international standards for electromagnetic emissions and immunity (EMC). The user is advised to avoid installation and use of this screener in proximity to other products or equipment that may emit or be susceptible to electromagnetic interference, including cellular phones. If the screener is used adjacent to other products or equipment, you are instructed to verify that no disturbance is found in the operation of this or other equipment in proximity.



CAUTION The screener and its components will perform reliably only when operated and maintained in accordance with the instructions contained in this directions for use, accompanying labels, and inserts. A defective product should not be used. Make sure all connections to external accessories are tight and secured properly. Parts which may be broken or missing or are visibly worn, distorted, or contaminated should be replaced immediately with clean, genuine replacement parts manufactured by or available from Welch Allyn.



CAUTION Equipment is not user repairable. Repairs and battery replacement must be performed only by a qualified service representative.



CAUTION Use and store the screener indoors only. Operate the screener within an ambient temperature range of 15°C / 59°F to 35°C / 95°F and in relative humidity between 30% and 90% (non-condensing).



CAUTION Transport and store the screener in temperatures between +5°C / 41° F to 40°C / 104° F.



CAUTION Annual calibration is recommended. Have an authorized Welch Allyn service technician perform electrical safety checks on the unit in order to maintain continued compliance with IEC and UL 60601-1.



CAUTION Do not open the case of the screener. Only Welch Allyn service personnel or an authorized repair center are authorized to perform warranty service. Performing unauthorized service on a screener that is within warranty may void the warranty.



CAUTION If the system is not functioning properly, do not operate it until all necessary repairs are made. Test and calibrate the screener for proper functionality in accordance with Welch Allyn published specifications before using.



CAUTION Do not drop or otherwise cause undue impact to the screener. If the screener is dropped or otherwise damaged, return it to Welch Allyn for repair and calibration. Do not use the screener if any damage is suspected.



CAUTION Recycle batteries whenever possible. In the United States call 1-800-8-BATTERY for information about recycling your lithium-ion battery or go to the RBRC website at www.rbrc.org for additional information.



CAUTION For Use by or on the order of a licensed medical professional.

Introduction

This directions for use describes the capabilities and operation of the Welch Allyn OAE Screener.

The purpose of the screener is to provide rapid screening of Distortion Product Otoacoustic Emissions (DPOAEs) or Transient Evoked Otoacoustic Emissions (TEOAEs) at several frequencies.

Intended use

The Welch Allyn OAE Hearing Screener is a test instrument that measures otoacoustic emissions in infants, children, and adults.

Indications for use

The Welch Allyn OAE Hearing Screener is indicated for testing of cochlear function in infants, children, and adults by measuring otoacoustic emissions (OAEs). The OAEs are generated by a series of clicks that are directed into the ear canal.

Otoacoustic emissions are low level audio-frequency sounds that are produced by the cochlea as part of the normal-hearing process. Available evidence suggests that otoacoustic emissions are generated by the cochlea's outer hair cells and that the presence of OAEs is an indication that the outer hair cells are viable. Clinical evidence indicates that these emissions normally occur with normal hearing, or at most, mild hearing loss (usually 30-40 dB HL). The majority of hearing-impaired individuals will be identified by a simple OAE test.

Note Some product features described in this publication might not be available in your country.

For information about any Welch Allyn product, contact Welch Allyn Technical Support: www.welchallyn.com/about/company/locations.htm.

OAE functionality

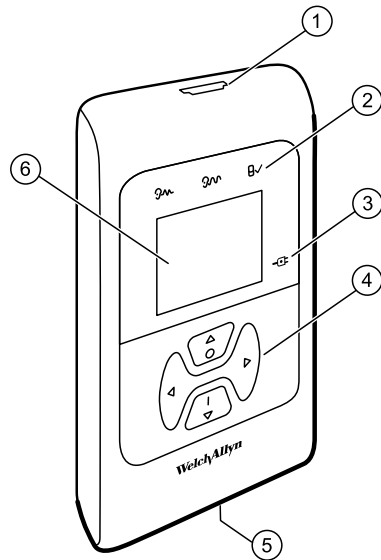

Item number	Description
1	Probe connector
2	Test status indicators
3	Charge status indicator
4	Control panel
5	Micro-USB Connector
6	Display

The system consists of the screener, probe, printer, single-use eartips, replaceable probe tubes, and other accessories. The screener contains the hardware and software for generating the test stimuli, measuring and displaying the OAEs, and storing the results until they are printed. The plastic housing contains circuit boards that provide the signal processing and display the test results.

The screener also contains a rechargeable lithium-ion battery. The screener displays the test status using a liquid-crystal display (LCD) and three light-emitting diodes (LEDs). You control testing, printing, and test protocol resets using four keypad push buttons.

The probe contains the speaker and microphone which produce test stimuli and measure the sound pressure level (SPL) present in the sealed ear canal. Interface of the instrument to the ear canal is accomplished through disposable eartips which fit onto the probe tube. The disposable eartips are color coded by size for easy selection.

Distortion product otoacoustic emissions (models 39500 and 39500-NP)

Distortion product otoacoustic emissions (DPOAEs) are acoustic signals that can be detected in the ear canal of a person with normal outer hair cell function, subsequent to stimulation of the auditory system with a pair of pure tones at frequencies f_1 and f_2 . The resulting emission of interest is the distortion product tone at the frequency $2f_1-f_2$.

The screener generates a series of test tones, directs them into the ear canal, and then measures the level of the DPOAE tone generated by the cochlea. By using different test frequencies, the screener provides an estimate of outer hair cell function over a wide range of frequencies.

Transient evoked otoacoustic emissions (models 39500-TE and 39500-TE-NP)

Transient Evoked Otoacoustic Emissions (TEOAEs) are acoustic signals that can be detected in the ear canal of a person with normal outer hair cell function, subsequent to stimulation of the auditory system with a series of wideband clicks.

The screener generates a series of clicks, directs them into the ear canal, and then analyzes the spectrum of the returning signal, separating the noise and emission. By using band pass filters, the screener provides an estimate of outer hair cell function over a wide range of frequencies.

Frequency Range tested

The frequency range tested is approximately 2 kHz to 5 kHz for DPOAEs. The frequency range for TEOAEs is 1.5 kHz to 4 kHz.

Results storage and reporting

When the screener is set in its default settings, the instrument stores the results from one patient (left and right ears) in its non-volatile memory for subsequent printing. The screener is capable of storing up to 250 test results.

The results are displayed on the LCD on the front of the device and are stored in the device's internal memory. After testing is complete, results can be printed using the printer or exported to a computer.

Sensitivity and specificity

Sensitivity and specificity in the screener are based on the test characteristics that you define and may vary, depending on environmental and operating conditions. The presence of otoacoustic emissions suggests normal outer hair cell function, which in turn correlates to normal hearing. However, a passing result using the screener is not an indication that the full auditory system is normal. Thus, a PASS result should not be allowed to override other indications that hearing is not normal. A full audiologic evaluation should be administered if concerns about hearing sensitivity persist. A REFER test result should not be assumed to be an indicator of a lack of auditory function; however, it should be followed with full audiologic diagnostic testing.

Setup

Unpack the system

The following parts are shipped standard with each screener system:

Number of items	Description
1	Welch Allyn OAE Screener Unit
1	Welch Allyn OAE Screener Probe
1	OAE Screener Cradle
1	Single Use Eartip Kit
1	Communications Cable, USB A/Micro-B
1	Communications Cable, USB A/B
1	Charging Cable, PSU 5V/Micro-B
1	Calibration Certificate
1	OAE Hearing Screen software CD includes: Quick Start Guide, Data Manager software DFU, and Data Manager software

If any part is missing, contact Welch Allyn Technical Support: www.welchallyn.com/about/company/locations.htm. We recommend that you save the shipping box and packing materials in case you need to store or ship the system.

Cradle

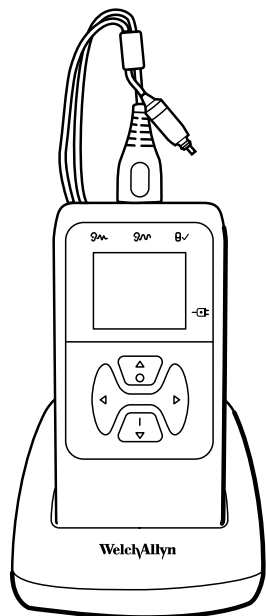

You can place the screener in the cradle to charge the device or to connect to a computer for communication with the Welch Allyn Data Manager (data manager). You can also charge the device or connect to a computer directly from the screener. The remainder of this directions for use assumes that you are charging the device or communicating with a computer from the screener.

Charge the battery

The screener is powered by an integrated, rechargeable lithium-ion battery providing 15 hours of operation between full charging. The battery status is indicated by the battery icon shown in the upper right corner of the Main Menu. Full battery charge is represented by a full battery symbol on the display and reduces to an empty battery in increments corresponding to the discharge of the battery.

Note Misalignment of the Micro-USB plug and socket can cause damage. The plug and socket should be visually inspected prior to each installation of the charging cable. If you see damage, contact Welch Allyn Technical Support: www.welchallyn.com/about/company/locations.htm.

Battery status indicator

A blue battery status indicator light, located to the right of the screen, lights up when the battery is charging and indicates the charging progress

The indicator light appears whenever the Micro-USB connector is engaged and powered. The illumination behavior identifies the status of the charging function, and is defined as follows:

- Steady: the battery is fully charged. This identifies that the charging cycle is complete. If the indicator is steady when you plug in the screener, the battery is fully charged.
- Slow blink: the battery is charging.

- Fast blink: a fault condition. Return the screener to Welch Allyn for service or repair. For information about returning any device to Welch Allyn, see "Repairs" and "Returning products."

When you use the screener, you are warned that the battery charge is low by two fast blinks followed by a pause and then two fast blinks. This sequence is repeated until you place the battery in the charge mode.

Charge the battery using the USB port

The screener is powered by an integrated, rechargeable lithium-ion battery providing 15 hours of operation between full charging. The battery status is indicated by the battery icon shown in the upper right corner of the Main menu. A lighted battery icon indicates a fully charged battery. The battery icon segments turn off as the battery charge decreases.

1. Insert the Micro-USB plug into the Micro-USB port on the bottom of the screener
2. Insert the wall charger into the mains outlet.

Charge the battery using the cradle

Note The Micro-USB port on the cradle does not support data transfer.

1. Insert the Micro-USB plug into the Micro-USB port on the back of the cradle.
2. Insert the wall charger into the mains outlet.

Install the probe

Insert the probe's HDMI connector firmly into the socket on the top of the screener. The plug fits only in one direction.

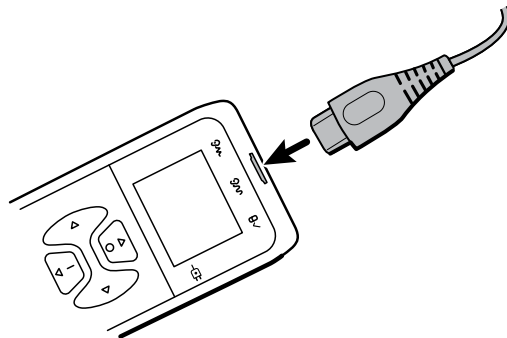

CAUTION Misalignment of the HDMI connector and socket can cause damage. The plug and socket should be visually inspected prior to each installation of the probe. If you see damage, contact Welch Allyn Technical Support: www.welchallyn.com/about/company/locations.htm.

Attach the probe tube

A clear probe tube must be attached to the probe head before an eartip is applied.

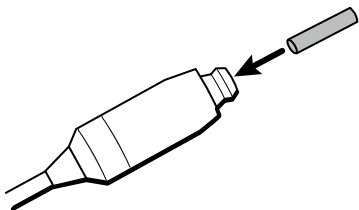

1. Insert a new probe tube into the probe head until it is fully seated.

A properly inserted probe tube snaps securely into place when it is fully seated in the probe head.

2. To remove a probe tube, grasp the tube and pull gently away from the probe head with a slight twist.

It is not necessary to replace the probe tube with each eartip; the tube is reusable as long as the probe tube is clear.



WARNING If the probe tube becomes dirty or clogged, it must be replaced. A dirty probe tube may produce wrong results.

Eartips

The screener comes with a box of disposable, single-use eartips that fit a variety of ear canal sizes. The determination of the appropriate eartip size should be made by persons with proper training and experience. The probe must have a probe tube applied and an eartip attached before inserting it into an ear canal. The eartip must seal the ear canal. The best test results are obtained when the eartip is inserted deeply into the ear canal instead of flush with the ear canal opening. Caution must be taken, however, to ensure that the eartip does not extend too deeply into the ear canal. Use only the eartips approved for use with the instrument. The eartips are disposable and must be replaced after each patient.

Attach and remove the eartips



WARNING A clear probe tube must be applied to the probe head before an eartip is applied.



WARNING The eartips are disposable and must be replaced after each patient. Failure to do so may cause infection.



WARNING The screener probe must have a probe tube and an eartip attached before inserting the screener probe into the ear canal. Failure to do so may cause infection.



WARNING A person with proper training and experience must determine the appropriate eartip size. Failure to do so may cause infection.



WARNING Ensure that the eartip does not extend too deeply into the ear canal. Failure to do so may cause infection.



WARNING If the probe tube becomes dirty or clogged, it must be replaced. Failure to do so may cause injury to the ear canal or wrong results or both.



WARNING Use only the eartips approved for use with the screener. Failure to do so may cause injury to the ear canal.

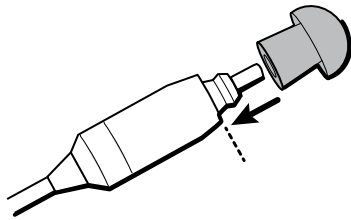

1. Select the appropriate-sized eartip.
2. Push and slightly twist the eartip onto the probe tube.

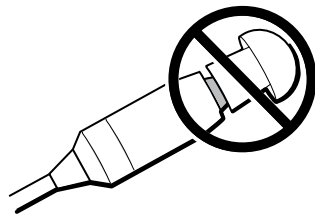

Ensure that the eartip is fully seated on the probe. There should be no gaps between the eartip and the collar of the probe head.

3. To remove the eartip, grasp the probe tube gently at the base and slightly twist it while pulling the eartip off of the probe tube.

Grasping the base of the probe tube will prevent it from being inadvertently pulled out of the probe head along with the eartip.

Probe holder

The probe holder is a receptacle attached to the HDMI cable that secures the probe when you are not using the screener. Placing the probe into the probe holder protects the probe head. Welch Allyn recommends that you insert the probe into the probe holder when the screener is not in use, such as when it is on a counter top or table, or when the screener is placed in the screener cradle.

Attach the probe holder

1. Place the probe holder near the end of the probe cable at the HDMI connector end.

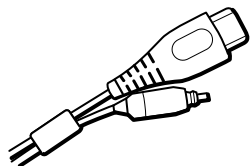

2. Gently press the probe cable into the probe holder close to the point of the probe head.

Clock settings

Set the date and time before using the screener. The clock should be set prior to testing because changing the date and time after tests are saved will not change the date on the printout.

Seasonal time changes, such as Daylight Saving Time, also require resetting the clock.

Note If the screener is being powered on for the first time or if the battery is completely discharged and is not charged within approximately one hour, an **Error! Reference source not found** may appear. If this message appears, reset the date and time.

Access the clock menu

1. While viewing the MAIN menu, press the **DOWN** control panel button.

The PROTOCOL menu appears.



2. While viewing the PROTOCOL menu, press the **DOWN** control panel button.

The clock menu appears with the current date and time.



Change the clock mode

The Clock Mode menu enables you to change the clock from a 24 hour mode to a 12 hour mode.

1. See "Access menus" for how to access menus.
2. On the control panel, press the **DOWN** button to advance to the **CLOCK MODE** menu.



3. Press either the **LEFT** or **RIGHT** control panel button to change from the 12 to 24 hour mode or from the 24 to 12 hour mode.
4. Press the **UP** control panel button repeatedly to return to the MAIN menu.

Change the date and time

1. If the date and time are correct, press the **UP** control panel button to return to the main menu. If either the date or time are not correct, go to **Step 2**.
2. If the month is incorrect, from the Main menu press the **DOWN** control panel button three (3) times to advance to the Month menu.
3. Press the **LEFT** or **RIGHT** control panel button to advance to the correct month.
4. Press the **DOWN** control panel button to advance to the Day menu
5. Press the **LEFT** or **RIGHT** control panel button to advance to the correct day.
6. Continue Steps 4–5 to correct the year, hour, and minute settings.
7. When the year and hour settings are correct, press the **UP** control panel button repeatedly to return to the Main menu.
8. If you are at the Minute menu, press the **DOWN** control panel button to return to the Main menu.

Device overview

Control panel



The screener uses four (4) buttons to control all functions. The arrows on the keypad (LEFT, RIGHT, UP, and DOWN) correspond to the arrows on the screen. Push the button that corresponds to the highlighted arrow on the screen in order to move through tasks.

Note The UP key always brings the screener back to either the previous menu or the main menu. The UP key will also access the print command from the Main menu.

Access menus

1. While viewing the MAIN menu, press the **down** control panel button on the control panel.

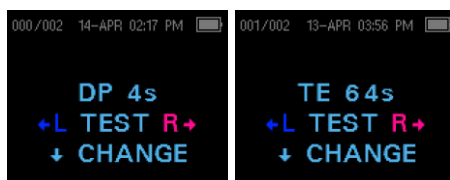

The PROTOCOL menu appears. DPOAE screeners will show DP 4s in the MAIN menu. TEOAE screeners will show TE 64s in the MAIN menu.

2. While viewing the PROTOCOL menu, press the **down** control panel button on the control panel.

The Clock menu appears with the current date and time.

3. While viewing the CLOCK menu, press the **down** control panel button on the control panel until the green LED READY light on the screener turns off.

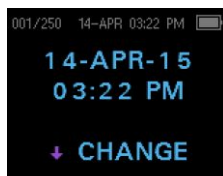

4. Release the **down** control panel button.

When you release the down button, the WIRELESS DEVICE screen appears and the menus are accessible.



5. Press the **down** control panel button to advance to other device settings.

Device settings

The screener menus enable you to change many of the screener settings or functions. These settings include:

- Wireless device pairing
- Clear test results
- Automatic shutdown interval
- Save mode
- Minimum amplitude value
- Clock Mode
- Graph style
- Normative Data for DPOAE
- Language
- Reset to default settings

Wireless device pairing

The wireless pairing menu enables you to pair the screener with a wireless device, such as a thermal printer or computer, for printing test results and data transfer. However, you can only pair one device with the screener at any given time.

Pair the screener and wireless device

Note When pairing to a computer for use with the data manager, confirm the computer has wireless availability or a wireless dongle will be required. Confirm the wireless settings of the computer by selecting 'Allow wireless devices to find this PC'.

1. Turn on the device to be paired with the screener.
2. On the screener, navigate to the **WIRELESS DEVICE** menu.
3. Press the **LEFT** or **RIGHT** control panel button to initiate discovery of available wireless devices.

The screener searches for available wireless devices for approximately 15 seconds. During this time the message "Please Wait" appears on the screen. The yellow LED light flashes.

4. When the correct computer appears on the screen, press the **DOWN** control panel button to pair the screener and computer.

The message "Add a device" appears on the computer.

5. Select this notice, and then enter PIN **1234**.
6. The first time the data manager software is launched, select **Detect Com Port** to finalize the screener and computer connection.
7. To cancel the pairing process, press the **CANCEL** control panel button.

The screener returns to the Main menu.

Select a wireless device

When discovery is complete, all discovered devices appear in the order in which they are found. A compatible thermal printer appears as " PRT-##-##" (for example, PRT-0a-de). Other devices appear by their name. These name configurations vary depending on the device.

1. See "Access menus" for how to access menus.
2. On the WIRELESS DEVICE menu, press either the **LEFT** or **RIGHT** control panel button to select the desired device.
3. Press the **PAIR** control panel button to pair the screener with the selected device.
The screen confirms pairing with the message "WIRELESS DEVICE PAIRED" .
4. Press the **MainMenu** control panel button to exit the wireless pairing menu.
5. See "Troubleshooting" in the Maintenance section if wireless pairing is unsuccessful or if any error messages appear.

Clear test results

The Test Results menu enables you to clear the test results stored in the screener without printing them.

1. See "Access menus" for how to access menus.
2. Press the **DOWN** control panel button to advance to the TEST RESULTS menu.

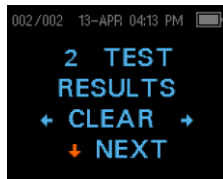

3. Press the **LEFT** or **RIGHT** control panel button to clear the results.
4. Press the **LEFT** or **RIGHT** control panel button to select Yes or No to clear the results.
5. Press the **NEXT** control panel button to advance to the next screen without clearing the results.

After printing results or transferring data to your computer, all tests saved in memory are marked for deletion and are permanently deleted when a new test is started. It is not necessary to manually clear these results.

6. Press the **UP** control panel button repeatedly to return to the MAIN menu.

Minimum amplitude

The Minimum Amplitude setting enables you to set the screening device to include minimum amplitude values in the PASS/REFER criterion. The minimum Distortion Product (DP) OAE amplitude is –5 dB SPL. The minimum Transient Evoked (TE) OAE amplitude selections are –5 dB or –10 dB SPL. If the MIN VALUE is set to ON, a result is not considered a pass unless the amplitude at each frequency is equal to or greater than the minimum value programmed into the screener. This is in addition to meeting the other pass criteria including the minimum SNR and the number of passing frequencies for an overall test PASS.

This feature is set to OFF when it is shipped from the factory.

Change the language

The LANGUAGE menu enables you to select the language used in the screener.

1. See "Access menus" for how to access menus.
2. Press the **DOWN** control panel button to advance to the **LANGUAGE** menu.



3. Press either the **LEFT** or **RIGHT** control panel button to scroll to the desired language.
4. Press the **UP** control panel button repeatedly to return to the MAIN menu.

Reset to default

The RESET TO DEFAULT menu returns all screener settings to its original factory defaults.

Reset to default settings

1. See "Access menus" for how to access menus.
2. Press the **DOWN** control panel button and advance to the RESET TO DEFAULT menu.

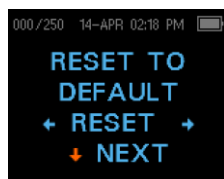

3. Press the **LEFT** or **RIGHT** control panel button.
4. Press the LEFT or RIGHT control panel button to select **Yes** or **No** to verify the reset or cancel your request.

Resetting to the factory default settings disconnects any wireless device, clears the test results, and resets all system settings.

5. Press the **UP** control panel button to return to the Main menu.

Operating instructions

Turn on the screener

Press the **DOWN** control panel button located below the display screen.

A yellow TEST light appears briefly above the display. The green READY light remains constant, indicating that the screener is ready to use. A Flash Screen appears briefly, displaying the software version, serial number, calibration date, and type of instrument, such as SCR Screener with DP or TE.

Automatic shutdown interval

The screener has an automatic shutdown feature designed to prolong battery life. The screener automatically shuts down after one (1) minute of inactivity, but the interval can be adjusted.

The interval choices are:

- 30 seconds
- 1 minute
- 2 minutes
- 4 minutes

See "Change the automatic shutdown interval" for directions on how to select a different interval.

Note To power on the screener, from the MAIN menu, press the **DOWN** control panel button. To power off the screener manually, from the MAIN menu, press the **UP** control panel button.

Change the automatic shutdown interval

The POWER OFF menu enables you to change the automatic shutdown interval.

1. See "Access menus" for how to access menus.
2. Press the **DOWN** control panel button to advance to the POWER OFF menu.

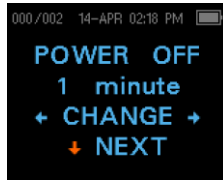

3. Press either the **LEFT** or **RIGHT** control panel button to change to the desired interval.
4. Press the **UP** control panel button repeatedly to return to the MAIN menu.

Main menu

The main menu has seven regions. The following screen and table define these regions.

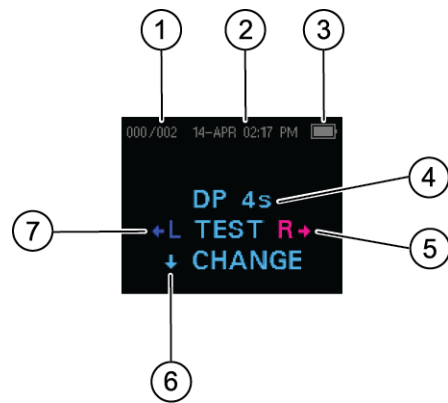

Number	Item	Definition
1	Number of stored tests	Displays the number of saved tests over the maximum possible tests
2	Date and time	The day/month, time, and AM/PM
3	Battery status	Displays the amount of charge remaining or the charging status when plugged into a mains outlet with the Micro-USB cable
4	Selected protocol	Displays protocol options: DP 4s (default) and DP 2s on DPOAE screeners, TE 64s (default) or TE 32s on TEOAE screeners
5	Start right ear test	Press to start a right ear test
6	Change protocol and settings	Press to change a protocol or screener settings (see Instrument Settings for more information)
7	Start left ear test	Press to start a left ear test

Select the test protocol

The DPOAE screener provides two (2) protocol options: DP 4s testing at a maximum time of 4 seconds per frequency and DP 2s testing at a maximum time of 2 seconds per frequency. The TEOAE screener provides two (2) protocol options: TE 64s testing a maximum time of 64 seconds and TE 32s testing a maximum 32 seconds. The last protocol used appears on the Main menu.

1. Press the **LEFT** or **RIGHT** control panel button on the Main menu.
The Change Protocol menu appears.
2. Press the **LEFT** or **RIGHT** control panel button to select the desired protocol.
3. Press the **UP** control panel button repeatedly to return to the Main menu and begin testing.
4. Press the **Down** control panel button to access the device menus.

See “Appendix E: Configurations and test protocols” for further information on protocol settings.

Prepare the patient for testing

Otoscopic examination of the patient’s ear canals is recommended prior to testing. Excessive cerumen or vernix in the ear canals may interfere with the test and give invalid or incomplete results. Patients with excessive cerumen, vernix, debris, or foreign bodies in the ear canals should be referred to a physician or other qualified health care professional for removal of the blockage prior to testing.

1. Place the patient in a position that will allow easy access to the ear canal.
2. Instruct the patient to remain quiet and still during the test.

Start a test

1. Gently pull up and back on the outer ear during eartip insertion to straighten the ear canal and ensure proper placement and seal.
2. Gently insert the eartip into the ear canal. It should fit snugly and comfortably.

Note The best test results are obtained when an eartip is inserted into the ear canal instead of flush with the ear canal.

3. Press either the **LEFT** or **RIGHT** control panel button for the TEST menu to select which ear is tested.

After the ear to be tested is selected, the AutoStart Probe Check begins automatically.

4. Repeat steps 1–3 to test the opposite ear.

AutoStart probe check

The Probe Check display shows a cone, larger at the left and tapering toward the right, representing the ear canal volume—from left to right—from very large (blue area) to very small (orange area).

Where the vertical white bar appears indicates the measured ear canal volume:

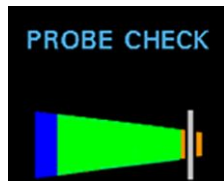
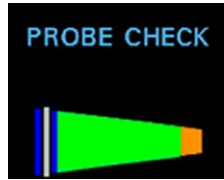

Ear canal volume	Explanation
Blue	The ear canal volume is too large for the test to begin. The probe is not in the ear or there is a large leak.
Green	The ear canal volume is in the target range for testing. The test will begin automatically if the probe fit is stable.
Orange	The ear canal volume is too small for the test begin. The eartip may be pressed against the ear canal wall or the probe tube may be completely clogged.
Gray	Ear seal indicator remains gray until a seal is obtained.

Troubleshoot the AutoStart probe check

Appropriate adjustments of the eartip position and size selection should be made until the indicator falls within the green area and remains stable. If the test will not progress past the AutoStart probe check stage:

1. Change the probe tube.
2. Confirm that the probe connector is fully seated in the socket.
3. Run the AutoStart probe check again.

Test results

Test phase

The screener automatically performs a calibration at the start of each test. During calibration a series of tones are sent to the ear canal to calibrate the levels of the frequencies to be tested. Following calibration of the test tones, the test phase begins automatically.

Note Press the **UP** control panel button to abort a test in progress. No record of an aborted test is saved in memory.

Graph styles

The results of a test are displayed as a graph. The graph is generated and shown during the test and can be viewed after the test is complete.

There are two graph options for viewing the results:

- The default view is a signal-to-ratio (SNR) bar graph. It displays the SNR for each DP test frequency or TE frequency band.
- The value graph view displays the absolute emission and noise levels for each DP test frequency or TE frequency band.

SNR bar graph view

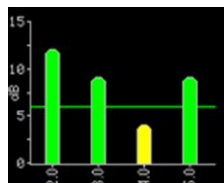

The default SNR bar graph view displays the emissions and noise floor (NF) as they are measured. Each column represents one DP test frequency or one TE frequency band. The height of each column represents the SNR being measured.

The horizontal green line at the decibel level corresponding to the SNR indicates the level required for a PASS. A green bar indicates a PASS and a yellow bar indicates a REFER.

See "Change graph style" for instructions on how to switch the graph views between SNR bar graph and value graph.

Value graph view

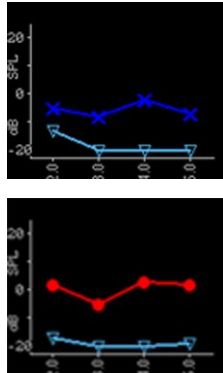

The value graph view uses different colors and symbols to differentiate the DP test frequency or TE frequency band for the left and right ear tests:

- Left ear: Dark blue line with "x" symbols indicate the DP test frequencies or TE frequency bands.
- Right ear: Red line with circles indicate the DP test frequencies or TE frequency bands.

On both the left and right ear value graphs, inverted triangles on a light blue line represent the NF at each DP test frequency or TE frequency band.

See "Change graph style" for instructions on how to switch the graph views between SNR bar graph and value graph.

Change graph style

The Graph menu enables you to change between the SNR and value graph views.

1. See "Access menus" for how to access menus.
2. Press the **DOWN** control panel button to access the GRAPH menu.
3. Press the **LEFT** or **RIGHT** control panel button to change between the SNR and value graph views.

Normative data display

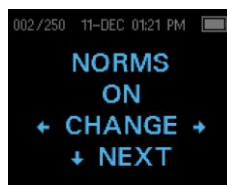

The Norms setting allows the user to display the Expanded Boys Town Norms template on the Value Graph for eligible DPOAE protocols. The normative data does not affect the PASS/REFER criteria or the results of the DP screening test. Norms are for viewing purposes only.¹

¹ The values used to create the template are shown in Table A1 from Gorga, M.P., Neely, S.T., Ohlrich, B., Hoover, B., Redner, J. and Peters, J. (1997). "From laboratory to clinic: a large scale study of distortion product otoacoustic emissions in ears with normal hearing and ears with hearing loss." *Ear & Hearing*, 18, 440-455.

Test techniques

As with other OAE test instruments, there are techniques to learn when using the screener, especially when screening infants. Experience with existing OAE systems suggests that it may take up to three (3) months to become completely proficient in screening infants.

Test an infant

Note The best test results are obtained when an eartip is inserted into the ear canal instead of flush with the ear canal.

When testing an infant with the screener, the infant has to be relatively quiet and calm; it is preferable that the infant be sleeping. If the infant is awake:

1. Use a pacifier to calm the infant; however, sucking adds noise to the test and decreases the likelihood of a PASS result.
2. Press either the **LEFT** or **RIGHT** control panel button to select which ear is tested.
3. Pull gently down and back on the pinna to straighten the ear canal.
4. Gently insert the eartip into the ear canal. It should fit snugly and comfortably.
5. Repeat steps 2–4 to test the opposite ear.

Test children with pressure equalizer tubes

Disable the AutoStart probe check when testing children with pressure equalizer (PE) tubes.

1. Pull gently up and back on the outer ear to straighten the ear canal.
2. Insert the probe with the appropriate eartip into the ear canal and obtain a proper seal.
3. Press and hold the arrow key that corresponds to the ear being tested until the green READY light turns off.
4. Release the arrow key.

The screener calibrates and tests as before, applying the appropriate in-the-ear stimulus intensity levels for patients with PE tubes.

5. Repeat steps 1-4 to test the opposite ear.

Noise sources

When the noise level exceeds the noise rejection limit of the screener, the red NOISE light appears. It is common for the red NOISE light to appear while testing. The light appears infrequently if the noise level in the ear canal is low, and it appear more frequently if the noise level in the ear canal is high.

For TEOAE screening protocols (TE 64s, TE 32s), the test will pause when noise levels exceed the noise rejection limit. Pause is indicated when the Noise, Test and Ready lights turn on simultaneously. Testing will automatically resume when noise levels decrease. Total pause time will not exceed 30 seconds.

OAEs are very low-level sounds. Any noise in the ear canal at the time of testing can mask this emission. This noise can come from a variety of sources.

The largest source of noise usually comes from the patient. This is biological noise, such as movement, coughing, sucking, talking, and the like. The patient must be calm and not move or talk. Ambient noise in the testing environment also can be a large source of noise during the test. A properly sealed eartip blocks much of this noise but performing the testing in a relatively quiet environment is recommended.

View results

When testing is complete, the green “READY” light is illuminated and the results for the ear tested appear. The results screen indicates the test ear and gives the results of the test.

The results are automatically saved in memory as soon as the test completes. The results are saved even if the screener is turned off or the battery is depleted.

Note When the screener is operating in the Save L/R Mode, the screener saves only the last test for each ear. Starting a new test for the same ear overwrites the existing test.

The following screens represent the possible test results:



- PASS: The ear tested passed screening.
- REFER: The ear tested did not pass screening.
- NOISY: Excessive noise was present during the test.
- NO SEAL: A seal was not maintained throughout the test.
- FIT ERR: Inadequate probe placement in the ear canal to produce target stimulus intensities.

See “Manage test results” for more information on managing results and how to print or transfer those results to the Welch Allyn Data Manager.

See “Save results” for more information on the screener save mode options.

Repeat an inconclusive test

A conclusive test has a PASS or REFER result. Repeat the test if the test result is NOISY, NO SEAL, or FIT ERR.

1. Reposition the probe, selecting a different size eartip if necessary.
2. Follow the directions that begin in “Select a protocol” to retest the patient.
3. To review the results, press the **DOWN** control panel button to return to the bar graph.
4. After reviewing the results, press the **DOWN** control panel button to return to the Results screen or the **UP** control panel button to return to the Main menu.

Manage results

Results storage and reporting

When the screener is set in its default settings, the instrument stores the results from one patient (left and right ears) in its non-volatile memory for subsequent printing. The screener is capable of storing up to 250 test results.

The results are displayed on the LCD on the front of the device and are stored in the device's internal memory. After testing is complete, results can be printed using the printer or exported to a computer.

Save/Store test results mode

The screener automatically saves the results of completed tests in the non-volatile memory even if the battery is temporarily discharged. However, the screener is not intended for long-term storage of test results.

Note You are strongly encouraged to print or transfer all test results at the completion of testing to avoid potential loss of data.

The screener has two operating modes for saving and storing test results:

- SAVE L/R
- SAVE 250

SAVE/LR is the default operating mode.

SAVE L/R mode

When operating in the default SAVE L/R mode, the screener saves the most recent test results for each ear and prints or transfers only these results. This allows you to retest a patient after a REFER result and to print or transfer only the most recent test result for each ear.

Welch Allyn recommends that you print the results after each patient when using the default mode.

SAVE 250 mode

When operating in the SAVE 250 mode, the screener can save up to 250 tests. There are two methods of using the SAVE 250 mode:

- When not used with the Welch Allyn Data Manager (data manager), the screener automatically numbers each test from 1 to 250. When using the SAVE 250 test mode for numbered tests, keep a record of the test number for each patient in order to synchronize the numbered test with the correct patient.
- When used with the data manager, the data manager transfers patient names to the screener and the screener displays the names.

When not used with the data manager, each test is automatically incremented, starting with test number 001.

When the screener is used with the data manager, the patient names are displayed on the screener in alphabetical order. See "View patient names" for directions on how to scroll between patient names.

When the screener reaches 245 saved tests, you are warned that the memory is almost full. When the screener reaches 250 saved tests, the memory is full and no further tests can be done. Do one of the following:

- Print the results,
- Transfer the results to the PC software
- Clear the results from memory.

Change the SAVE mode between SAVE L/R and SAVE 250

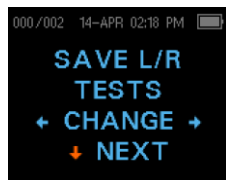

Before changing the SAVE mode, print all tests stored in memory.

1. See "Access menus" for how to access menus.
2. Press the **DOWN** control panel button to advance to the SAVE L/R screen.
3. Press the **LEFT OR RIGHT** control panel button to change between the SAVE L/R (single) setting and SAVE 250 (multiple) setting.
4. Press the **UP** control panel button repeatedly to return to the MAIN menu.

View patient names

When patient names are uploaded from the data manager to the screener, the patient names are displayed on the screener in alphabetical order. The first name shown is labeled "Unnamed" to allow tests to be conducted on patients whose names have not been transferred.

To move to a different patient name than the one displayed on the screener, press the **LEFT** or **RIGHT** control panel button to advance through the names until the desired patient name appears.

Delete test results

The screener holds data in non-volatile memory. The data stays in the memory even after data is printed on the thermal printer or downloaded to the data manager. The save mode determines how data is deleted.

Delete results in SAVE L/R mode

The most recent test for the left ear and the most recent test for the right ear are held in memory. Data is deleted when a new test for the left or right ear is completed.

1. See "Access menus" for how to access menus.
2. Press the DOWN control panel button to advance to the X TEST RESULTS menu. "X" represents the number of tests held in memory in the screener.
3. Press the **LEFT** or **RIGHT** control panel button.
4. Press the **LEFT** or **RIGHT** control panel button, and then press the appropriate **LEFT** or **RIGHT** control panel button to select **YES** or **NO** to verify or cancel your choice.

If you select YES, the data is cleared from the screener. After printing results or transferring data to your PC software, all tests saved in memory are marked for deletion and are permanently deleted when a new test is started. It is not necessary to manually clear these results.

Delete results in SAVE 250 mode

Data is deleted when new Patient Names are uploaded from the data manager to the screener. A warning is provided that data will be deleted. Data can be deleted in the screener from the data manager when the screener is connected to the data manager by the USB cable or by wireless. When Names is selected, the window allows data to be deleted using the Clear Instrument button.

To delete data using the TEST RESULTS menu:

1. See "Access menus" for how to access menus.
2. Press the **DOWN** control panel button to advance to the TEST RESULTS screen.
3. Press the **LEFT** or **RIGHT** control panel button.
4. Press the **LEFT** or **RIGHT** control panel button, and then press the appropriate **LEFT** or **RIGHT** control panel button to select **YES** or **NO** to verify or cancel your choice.

If you select YES, the data is cleared from the screener. After printing results or transferring data to your PC software, all tests saved in memory are marked for deletion and are permanently deleted when a new test is started. It is not necessary to manually clear these results.

Connect the screener to a computer

1. Power on the screener and ensure that the screener is charged.
2. Plug the micro-USB connector into the port on the bottom of the screener.
3. Plug the USB connector into a USB port on the computer.
4. Power on the computer, and then launch the data manager.

The message, "Waiting On PC" appears on the screener.

5. Begin data or name transfers.

Connect the screener cradle to a computer

Use a standard USB-A to USB-B cable to connect the screener cradle to a computer.

1. Power on the screener and ensure that the screener is charged.
2. Plug the USB-B connector into the port on the back of the screener cradle.
The cradle does not need to be connected to a mains outlet for data transfer.
3. Plug the USB-A connector into a USB port on the computer.
4. Place the screener in the cradle.
5. Power on the computer, and then launch the data manager.
The message, "Waiting On PC" appears on the screener.
6. Begin data or name transfers.

You must use a USB-A to USB-B cable between the cradle and the computer for data transfer. The micro-USB port on the cradle does not support data transfer. Use the cradle for recharging the screener when power is supplied to the either the micro-USB or the USB-B port. Use the micro-USB port on the bottom of the screener for both data transfer and recharging.

Connect the screener to a computer using wireless

1. Welch Allyn OAE ScreenerDFU1.0Power on the screener and ensure that the screener is charged.
2. Power on the computer, and then launch the data manager.
The message, "Waiting On PC" appears on the screener.
3. If this is the first time the screener is being connected using wireless, then on the Transfer section of the Home tab, click **Detect Com Port**.
4. Ensure that the screener is paired to your computer.
Pairing is only required upon initial data transfer.
5. On the Main menu of the screener, press the **UP** control panel button.
The wireless menu appears.
6. Press the **LEFT** or **RIGHT** control panel button to begin data or name transfers.

Pair the screener and wireless device

Note When pairing to a computer for use with the data manager, confirm the computer has wireless availability or a dongle will be required. Confirm that the computer is discoverable and that wireless devices can pair with it.

1. Turn on the device to be paired with the screener.
2. On the screener, navigate to the **New Wireless Device** menu.
3. Press the **LEFT** or **RIGHT** control panel button to initiate discovery of available wireless devices.

The screener searches for available wireless devices for approximately 15 seconds. During this time the message "Please Wait" appears on the screen. The yellow LED light flashes.

4. When the correct computer appears on the screen, press the **DOWN** control panel button to pair the screener and computer.
The message "Add a device" appears on the computer.
5. Select this notice, and then enter PIN **1234**.
6. The first time the data manager software is launched, select **Detect Com Port** to finalize the screener and computer connection.
7. To cancel the pairing process, press the **CANCEL** control panel button.
The screener returns to the Main menu.

Print to a thermal printer

You must have an optional wireless thermal printer to print from the screener. See "Pair the screener and wireless device" for directions. You can only pair one device with the screener at any given time.

1. Confirm that the printer is on and ready for printing.
2. Confirm that the screener is paired with the printer.
3. From the main menu, press the **UP** control panel button.



The CONNECT TO PRT screen appears.

4. Press the **LEFT** or **RIGHT** control panel button to connect to the printer.

The screener searches for the paired printer; when the screener pairs with the printer, all stored results print. All printed test results are marked for deletion, but are stored in memory until a new test is started. This enables you to reprint the tests if printing was unsuccessful due to the paper running out or other issue. This also allows you to transfer test data to the data manager for long term storage before you start a new test. When a new test is started, all tests in the screener memory are erased. The screener turns off automatically when printing is complete.

Understand printed results

DPOAE printout

The following information is provided for each test:

- The time and date of the test, based on the setting of the internal clock; if the clock is set correctly, this time and date will be correct
- The test number (if operating in SAVE 250 mode)
- The protocol selected (for example, DP 2s)
- The averaging time used for this test (for example, 2 sec avg)
- Instrument and probe serial number (SN)
- The software version number (for example, V104.04)
- The ear selected (Right or Left)
- A PASS/REFER indication
- The f2 frequency in kHz (for example, 2.0, 3.0, 4.0, 5.0)
- The noise floor (NF) in dB SPL
- The emission level (DP) in dB SPL
- The signal-to-noise ratio (SNR)—DP level minus the NF—in dB
- The Value or SNR graph as selected on the screener
- "MIN*" if the Minimum Amplitude setting was enabled

TEOAE printout

The following information is provided for each test:

- The time and date of the test, based on the setting of the internal clock; if the clock is set correctly, this time and date will be correct
- The test number (if operating in SAVE 250 mode)
- The protocol selected (for example, TE 64s)
- The averaging time used for this test (for example, 12 sec avg)
- Instrument and probe serial number (SN)
- The software version number (for example, V104.04)
- The ear selected (Right or Left)
- A PASS/REFER indication if there is a criterion set for the selected protocol
- The frequency band center (F)

- The noise floor (NF) in dB SPL
- The emission level (TE) in dB SPL
- The signal-to-noise ratio (SNR)—DP level minus the NF—in dB
- The Value or SNR graph as selected on the screener
- "MIN*" if the Minimum Amplitude setting was enabled

Rounding results

The SNR and single PASS criterion are calculated from the full internal precision of the screener and not from the rounded values shown in the printout for the emission (DP or TE) and NF estimates.

This approach is used to preserve the full precision of the test results but can result in some apparent errors in the printout due to the effects of rounding. Assume that the actual values at a given frequency were DP = 5.5 dB and NF = -0.4 dB, which results in a SNR = 5.9 dB. The printout values are rounded up to the nearest integer and are shown as DP = 6, NF = 0, and SNR = 6. This can result in what appears to be an error, based on the PASS criterion. If the PASS criterion is 6 dB while the actual SNR is 5.9, the printed value will be 6 but the frequency will not be judged as a PASS with a "P" printed.

Maintenance

General maintenance



WARNING A defective screener should not be used. Confirm that all connections to external accessories are seated and secured properly. Parts which may be broken or missing or are visibly worn, distorted, or contaminated should be replaced immediately with clean, genuine replacement parts manufactured by or available from Welch Allyn. Failure to do so may cause infection.

The screener requires no regular maintenance beyond routine cleaning and annual calibration. Replace the probe tube if it becomes clogged.

The screener is not user repairable. Repairs and battery replacement must be performed only by a qualified Welch Allyn service representative.

Annual calibration is recommended. An authorized service technician should perform electrical safety checks in order to maintain continued compliance with IEC and UL 60601-1.

Clean and disinfect



WARNING Eartips are for single patient use only. Failure to do so may cause infection.



WARNING Use a new eartip for each patient. Failure to do so may cause infection.



CAUTION Do not insert any object into probe. Exposing the device to these conditions may affect the stability of the device.



CAUTION Do not immerse the instrument or probe in fluids or attempt to sterilize the instrument or any of its accessories. Exposing the device to these condition may affect the stability of the device.



CAUTION Do not allow any fluid to enter the device. Exposing the device to these conditions may affect the stability of the device.



CAUTION Do not use autoclave sterilization. Exposing the device to these conditions may affect the stability of the device.



CAUTION Do not use alcohol-based disinfectants. Exposing the device to these conditions may affect the stability of the device.



CAUTION Do not put excessive pressure on the clear display window or allow any utensil to puncture the display window or control panel. Putting excessive pressure on the clear display window or puncturing the display window or control panel with any utensil may affect the stability of the device.



CAUTION Do not puncture the display window or control panel. Puncturing the display window or control panel with any utensil may affect the stability of the device.



CAUTION Long-term exposure to disinfecting agents has the potential to alter the material properties of the plastic housing and labeling of the device. Exposing the device to these condition may affect the stability of the device.



CAUTION Always follow the safety and disposal guidelines for cleaning and disinfectant chemicals provided by the manufacturer. Failure to do so may affect the stability of the device.

Note

The probe tube, which does not make direct contact with the patient, should be replaced if there is any sign of contamination or if the test will not progress past the AutoStart phase. You do not need to disinfect the probe tube between patients.

Use a new eartip for each patient. Eartips are for single patient use only. The probe tube, which does not make direct contact with the patient, should be replaced if there is any sign of contamination or if the test will not progress past the AutoStart phase. Disinfection of the probe tube between patients is not required.

External parts of the instrument/probe can be cleaned to remove visible particulate contamination. Do not attempt to insert any object into probe.

This instrument is not designated as a "sterile" device. Wiping with a clean cloth or towel provides suitable cleaning of the housing and probe exterior. Repeat this weekly, or as often as conditions warrant, to prevent a build-up of grime from normal handling and use.

Low-level disinfection is appropriate for this type of instrument, but this standard might not conform to the infection control guidelines of your facility. The disinfecting materials and procedures applied in your facility might be more stringent for your circumstances than the methods outlined above. The frequency of cleaning and disinfecting depends on the facility's risk assessment, usage, and test environment.

Calibrate the screener

Calibrate your screener every 12 months for measurement accuracy. Failure to do so may affect the stability of the device.

Replace the probe tube

Probe tubes are disposable and should be replaced when they become clogged. Replacement probe tubes are included with the screener.

1. Grasp the probe head with the fingertips of one hand.
2. Use the eartip to grasp the clear, plastic probe tube with the fingertips of your other hand.

3. Twist the probe head slightly while pulling the eartip and probe tube straight out of the probe head.
4. Dispose of the used probe tube immediately to avoid confusing used tubes and new tubes.
5. Insert a new probe tube into the probe head until it is fully seated.

A properly inserted probe tube snaps securely into place when it is fully seated in the probe head.



CAUTION Do not attempt to clean probe tubes. This may cause damage to the probe head.

Repairs

A Welch Allyn Service Center must perform all repairs on products under warranty, unless you have purchased a Welch Allyn Partners in Care Biomed agreement allowing you to service the device while under warranty.



CAUTION Unauthorized repairs will void the product warranty.

Qualified service personnel or a Welch Allyn Service Center should repair products out of warranty.

If you are advised to return a product to Welch Allyn for repair or routine maintenance, schedule the repair with the service center nearest you.

Welch Allyn Technical Support

If you have a problem with the device that you cannot resolve, call the Welch Allyn Technical Support Center nearest you for assistance. A representative will assist you in troubleshooting the problem and will make every effort to solve the problem over the phone, potentially avoiding an unnecessary return.

If your product requires warranty, extended warranty, or non-warranty repair service, a Welch Allyn Technical Support representative will record all necessary information to issue a RMA number. The support representative will provide you with the address of the Welch Allyn Service Center to send your device to.

Technical support is available during local business hours.

Troubleshooting

Problem	Solutions
Instrument does not turn on	<ul style="list-style-type: none"> • Press the DOWN arrow until the Yellow LED light appears. • Connect the charger. Confirm that blue "Charging" LED is illuminating in a slow blink pattern. Wait at least 10 minutes and then attempt to turn on the screener • If the problem persists, contact Welch Allyn Technical Support: www.welchallyn.com/about/company/locations.htm.
The test will not start	<ul style="list-style-type: none"> • Select a different sized eartip. • Reposition the probe. • Be sure the probe cable is secured with the shirt clip. • Change the probe tube. • Verify from the probe check during AUTOSTART that the eartip is sealed in the ear canal. • Check that the instrument will start in your own ear using the proper eartip for your ear. If the test will not start or if the AutoStart tones sound unusual, replace the probe tube. • If the problem persists across several patients, contact Welch Allyn Technical Support: www.welchallyn.com/about/company/locations.htm.
The results will not print	<ul style="list-style-type: none"> • Check the printer status. Turn the printer on or wake from sleep mode. • If the printer does not turn on, plug in the power supply to charge the battery. • Confirm that the printer has paper. • If paper comes out of the printer but there is no text on the paper, then the paper is inserted backwards. • Rapidly press the large printer button twice to run a demonstration print. • If the problem persists, contact Welch Allyn Technical Support: www.welchallyn.com/about/company/locations.htm.

Problem	Solutions
Display is frozen and instrument will not respond to button presses	<ul style="list-style-type: none"> • Press and hold the UP arrow for 10 seconds to force the instrument to power off. Powering the instrument on should reset/restore normal function. • If the problem persists, contact Welch Allyn Technical Support: www.welchallyn.com/about/company/locations.htm.
TE screening test is paused	<ul style="list-style-type: none"> • Re-insert probe tip into ear canal • Reposition the probe tip • Wait for noise levels to decrease; test will resume
Message	Solutions
Attach Probe	<ul style="list-style-type: none"> • Probe not detected. • Check that the probe connector is fully seated in the socket. • Disconnect and reconnect the probe. • Cycle instrument power.
Wireless Device Not Found	<ul style="list-style-type: none"> • Paired to Printer: <ul style="list-style-type: none"> ○ Check that the printer is turned on. ○ Move closer to the printer. ○ Try again. • Paired to PC Computer or wireless dongle: <ul style="list-style-type: none"> ○ Check that the serial port is open. Establishing the serial port is handled by the PC and/or the software, not by the Welch Allyn OAE Screener.
Wireless Error #xxx	<ul style="list-style-type: none"> • Check wireless device (printer or PC) status. • Attempt to connect to wireless device again. • If the problem persists, contact Welch Allyn Technical Support: www.welchallyn.com/about/company/locations.htm.
Wireless Not Configured	<ul style="list-style-type: none"> • Printing has been attempted, but no wireless device is paired with the Welch Allyn OAE Screener. Establish wireless pairing.
Device Not Responding	<ul style="list-style-type: none"> • The printer is not responding to queries from the instrument. Check printer status.
Due for service	<p>Verify Device date / time is set correctly.</p> <p>Annual calibration is due. Reminder message will re-appear every 24-hour period until re-calibrated. Contact Welch Allyn to schedule annual calibration.</p>
Fit Error Cannot Obtain	<ul style="list-style-type: none"> • The desired intensity level (L1 or L2) cannot be obtained within allowable limits. User should refit the probe and retry the test. • Replace the probe tube. • If the problem persists across several patients, contact Welch Allyn Technical Support: www.welchallyn.com/about/company/locations.htm.
Fit Error Too High	<ul style="list-style-type: none"> • The level of the calibration tone is too high. Refit the probe and retry the test. • Replace the probe tube.

Message	Solutions
	<ul style="list-style-type: none">• If the problem persists across several patients, contact Welch Allyn Technical Support: www.welchallyn.com/about/company/locations.htm.
Fit Error Too Low	<ul style="list-style-type: none">• The level of the calibration tone is too low. User should refit the probe and retry the test.• Replace the probe tube.• If the problem persists across several patients, contact Welch Allyn Technical Support: www.welchallyn.com/about/company/locations.htm.
Limit Error	<ul style="list-style-type: none">• Overflow error during the calculation of the DFTs for a DP test. Repeat the test.• Cycle instrument power.• If the problem persists, contact Welch Allyn Technical Support: www.welchallyn.com/about/company/locations.htm.
Memory almost full	<ul style="list-style-type: none">• Saved tests are within 5 tests of the maximum limit. Print or transfer test results to avoid interruption in testing.
Memory Full!	<ul style="list-style-type: none">• The maximum number of saved tests has been reached. Clear the memory in order to perform additional tests.
Power Low!	<ul style="list-style-type: none">• The battery charge level is too low for operation. Charge the battery in order to perform additional tests.
Printer Error	<ul style="list-style-type: none">• Indicates a problem with the printer.• Check the printer status.• Reset the printer or cycle the printer power.
Printer Paper Out!	<ul style="list-style-type: none">• Replace the paper roll.
Time/Date Error	<ul style="list-style-type: none">• The clock is checked during power on to ensure it has not lost time and been reset. In the case of clock reset, this message is shown. Set the correct date/time.

Status/Error messages

Display messages

Message	Definition
Attach Probe	No probe is detected at the start of a test.
Device not Responding	The printer is not responding to queries from the instrument.
Wireless Device Not Found	The paired wireless device cannot be detected by the screener. The screener may be turned off or too far away.
Wireless Error #xxx.	There is an error condition with the wireless device. Check the status.
Wireless Not Configured	The screener is not paired with any wireless device.
Fit Error Cannot Obtain P	For a DP test, the desired intensity level (L1 or L2) cannot be obtained within allowable limits. Refit the eartip and probe and attempt the test.
Fit Error Too High	The level of the calibration tone is too high. Refit the eartip and probe and retry the test.
Fit Error Too Low	The level of the calibration tone is too low. Refit the eartip and probe and retry the test.
Limit Error	Overflow error during the calculation of the DFTs for a DP test. Repeat the test.
Memory Almost Full	Saved tests are within 5 tests of the 250 maximum limit.
Memory Full!	The maximum saved test limit of 250 is reached. Clear the memory before any additional tests can be performed.
Power Low!	The battery charge level is too low for operation. Charge the battery in order to administer additional tests.
Printer Error	There is a problem with the printer. Check the printer status.
Printer Paper Out!	The printer paper has run out. Load printer paper.
Time/Date Error	The clock is checked during power on to ensure it has not lost time and been reset. In the case of clock reset, this message is shown. Set the correct date/time.

Standards and compliance

General compliance and standards

The Welch Allyn OAE screener complies with the following standards:

Standard	Issue Date	Title
ANSI/ASA 3.6	2010	Specification for Audiometers
IEC 60601-1	2005	Medical Electrical Equipment – General Requirements for Basic Safety and Essential Performance, Ed. 3
IEC 60645-1	2004	Electroacoustics - Audiological equipment -- Part 1: Pure-tone audiometers
IEC 60645-3	2007	Electroacoustics - Audiometric equipment -- Part 3: Test signals of short duration
IEC 60645-6	2010	Electroacoustics – Audiometric Equipment – Part 6: Instruments for the measurement of otoacoustic emissions
ISO 14971	2012	Application of Risk Management to Medical Devices
ISO 10993	2009	Biological Evaluation of Medical Devices
EN 60601-1-2	2014	Medical electrical equipment -- Part 1-2: General requirements for basic safety and essential performance - Collateral standard: Electromagnetic compatibility - Requirements and Tests.
FCC Part 15	2015	FCC 47CFR, Part 15.247 & 15.249



**Directive 2002/96/EC-WEEE:
Disposal of noncontaminated electrical and electronic equipment**

Many local laws and regulations require special procedures to recycle or dispose of electrical equipment-related waste including batteries, printed circuit boards, electronic components, wiring and other elements of electronic devices. Follow all of your respective local laws and regulations for the proper disposal of batteries and any other parts of this system. Do not dispose of this product as unsorted municipal waste. Prepare this product for reuse or separate collection as specified by Directive 2002/96/EC of the European Parliament and the Council of the European Union on Waste Electrical and Electrical Equipment (WEEE). If this product is contaminated, this directive does not apply.

For specific disposal or compliance information contact, contact Welch Allyn Technical Support.



WARNING Batteries may explode or cause burns, if disassembled, crushed or exposed to fire or high temperatures.

EMC compliance

Special precautions concerning electromagnetic compatibility (EMC) must be taken for all medical electrical equipment. This device complies with IEC EN 60601-1-2:2014.

- All medical electrical equipment must be installed and put into service in accordance with the EMC information provided in this document, the *Welch Allyn® OAE Hearing Screener Directions for use*.
- Portable and mobile RF communications equipment can affect the behavior of medical electrical equipment.

The device complies with all applicable and required standards for electromagnetic interference.

- It does not normally affect nearby equipment and devices.
- It is not normally affected by nearby equipment and devices.
- It is not safe to operate the central station in the presence of high-frequency surgical equipment.
- However, it is good practice to avoid using the device in extremely close proximity to other equipment.



WARNING The use of the device adjacent to or stacked with other equipment or medical electrical systems should be avoided because it could result in improper operation. If such use is necessary, the device and other equipment should be observed to verify that they are operating normally.



WARNING Use only Accessories recommended by Welch Allyn for use with the device. Accessories not recommended by Welch Allyn may affect the EMC emissions or immunity.



WARNING Maintain minimum separation distance between the device and portable RF communication equipment. Performance of the device may be degraded if proper distance is not maintained.

Emissions and immunity information

Electromagnetic emissions

The Welch Allyn® OAE Hearing Screener is intended for use in the electromagnetic environment specified below. The customer or user of the Welch Allyn® OAE Hearing Screeners should assure that it is used in such an environment.

Emissions test	Compliance	Electromagnetic environment - guidance
RF emissions CISPR 11	Group 1	The Welch Allyn® OAE Hearing Screener uses RF energy only for its internal function. Therefore, its RF emissions are very low and are not likely to cause any interference in nearby electronic equipment.
RF emissions CISPR 11	Class B	The Welch Allyn® OAE Hearing Screener is suitable for use in all establishments other than domestic and those directly connected to the public low-voltage power supply network that supplies buildings used for domestic purposes.
Harmonic emissions IEC 61000-3-2	Class A	 WARNING This equipment/system is intended for use by healthcare professionals only. This equipment/ system may cause radio interference or may disrupt the operation of nearby equipment ^a . It may be necessary to take mitigation measures, such as re-orienting or relocating the monitor or shielding the location.
Voltage fluctuations/ flicker emissions IEC 61000-3-3	Complies	

^a The device contains a 2.4-GHz frequency hopping spread-spectrum transmitter for the purpose of wireless communication. The radio is operated according to the requirements of various agencies, including FCC 47 CFR 15.247 and RED Directive (20145/53/EU). The transmitter is excluded from the EMC requirements of 60601-1-2, but should be considered when addressing possible interference issues between this and other devices.

Electromagnetic immunity

The Welch Allyn® OAE Hearing Screener is intended for use in the electromagnetic environment specified below. The customer or the user of the Welch Allyn® OAE Hearing Screener should assure that it is used in such an environment.

Immunity test	IEC 60601 test level	Compliance level	Electromagnetic environment - guidance
Electrostatic discharge (ESD) IEC61000-4-2	±8 kV contact ±15 kV air	± 8 kV contact ±15 kV air	Floors should be wood, concrete or ceramic tile. If floors are covered with synthetic material, the relative humidity should be at least 30%.
Electrical fast transient/burst IEC 61000-4-4	±2 kV for power supply lines ±1 kV for input/output lines	±2 kV for power supply lines ±1 kV for input/output lines	Mains power quality should be that of a typical commercial or hospital environment.
Surge IEC 61000-4-5	±1 kV differential mode ±2 kV common mode	±1 kV differential mode ±2 kV common mode	Mains power quality should be that of a typical commercial or hospital environment.
Voltage dips, short interruptions and voltage variations on	<0 % U_T (>100 % dip in U_T) for 1 cycle 70 % U_T (30 % dip in U_T) for 25/	<0 % U_T (>100 % dip in U_T) for 1 cycle 70 % U_T (30 % dip in U_T) for 25/	Mains power quality should be that of a typical commercial or hospital environment. If the user of the Welch Allyn® OAE Hearing Screener requires continued operation during power

Electromagnetic immunity

power supply input lines IEC 61000-4-11	30 cycles <0 % U_T (>100 % drop in U_T) for 0.5 cycles@ 0°, 45°, 90°, 135°, 180°, 225°, 270°, and 315° for 250/300 cycles	30 cycles <0 % U_T (>100 % drop in U_T) for 0.5 cycles@ 0°, 45°, 90°, 135°, 180°, 270°, and 315° for 250/300 cycles	mains interruptions, it is recommended that the Welch Allyn® OAE Hearing Screener be powered from an uninterruptible power supply or a battery.
Power frequency (50/60 Hz) magnetic field IEC 61000-4-8	30 A/m	30A/m	Power frequency magnetic fields should be at levels characteristic of a typical location in a typical commercial or hospital environment.

Note: U_T is the a.c. mains voltage prior to application of the test level.

Electromagnetic immunity

The Welch Allyn® OAE Hearing Screener is intended for use in the electromagnetic environment specified below. The customer or the user of the Welch Allyn® OAE Hearing Screener should assure that it is used in such an environment.

Immunity test	IEC 60601 test level	Compliance level	Electromagnetic environment - guidance
			Portable and mobile RF communications equipment should be used no closer to any part of the Welch Allyn® OAE Hearing Screener, including cables, than the recommended separation distance calculated from the equation applicable to the frequency of the transmitter.
			Recommended separation distance
Radiated disturbance variables according to IEC 61000-4-3	10 V/m 80 MHz to 2.7 GHz	10 V/m 3V	$d = (1.17) \sqrt{P}$
Conducted disturbance variables according to IEC 61000-4-6	Effective value 3 V 150 kHz to 80 MHz Effective value 6V ISM frequency bands 0.15 MHz to 80 MHz	6V	$d = (1.2) \sqrt{P}$ 80 to 800 MHz $d = (2.33) \sqrt{P}$ 800 MHz to 2.5 GHz
			where P is the maximum output power rating of the transmitter in watts (W) according to the transmitter manufacturer and d is the recommended separation distance in meters (m). Field strengths from fixed RF transmitters, as determined by an electromagnetic site survey ^a , should be less than the compliance level in each frequency range ^b . Interference may occur in the vicinity of equipment marked with the following symbol:
			

Note 1: At 80 MHz and 800 MHz, the higher frequency range applies.

Note 2: These guidelines may not apply in all situations. Electromagnetic propagation is affected by absorption and reflection from structures, objects, and people.

Electromagnetic immunity

^a Field strengths from fixed transmitters, such as base stations for radio (cellular/cordless) telephones and land mobile radios, amateur radio, AM and FM radio broadcast, and TV broadcast cannot be predicted theoretically with accuracy. To assess the electromagnetic environment due to fixed RF transmitters, an electromagnetic site survey should be considered. If the measured field strength in the location in which the Welch Allyn® OAE Hearing Screener is used exceeds the applicable RF compliance level above, the Welch Allyn® OAE Hearing Screener should be observed to verify normal operation. If abnormal performance is observed, additional measures may be necessary, such as reorienting or relocating the Welch Allyn® OAE Hearing Screener.

^b Over the frequency range 150 kHz to 80 MHz, field strengths should be less than 3 V/m.

Recommended separation distances between portable and mobile RF communications equipment and the Welch Allyn® OAE Hearing Screener

The Welch Allyn® OAE Hearing Screener is intended for use in an electromagnetic environment in which radiated RF disturbances are controlled. The customer or user of the Welch Allyn® OAE Hearing Screener can help prevent electromagnetic interference by maintaining a minimum distance between portable and mobile RF communications equipment (transmitters) and the Welch Allyn® OAE Hearing Screener as recommended below, according to the maximum output power of the communications equipment.

Separation distance according to frequency of transmitter (m)

Rated max. output power of transmitter (W)	150 kHz to 80 MHz $d = (1.17) \sqrt{P}$	80 MHz to 800 MHz $d = (1.17) \sqrt{P}$	800 MHz to 2.5 GHz $d = (2.33) \sqrt{P}$
0.01	0.12	0.12	0.23
0.1	0.37	0.37	0.74
1	1.20	1.20	2.30
10	3.70	3.70	7.40
100	12	12	23

For transmitters rated at a maximum output power not listed above, the recommended separation distance d in meters (m) can be estimated using the equation applicable to the frequency of the transmitter, where P is the maximum output power rating of the transmitter in watts (W) according to the transmitter manufacturer.

Note 1: At 80 MHz and 800 MHz, the separation distance for the higher frequency range applies.

Note 2: These guidelines may not apply in all situations. Electromagnetic propagation is affected by absorption and reflection from structures, objects, and people.

Warranty

Welch Allyn warrants that this product is free from defects in material and workmanship and, when properly installed and used, will perform in accordance with applicable specifications. If within one year after original shipment, it is found not to meet this standard; it will be repaired, or at our option, replaced at no charge except for transportation costs, when returned to an authorized Welch Allyn facility. If field service is requested, there will be no charge for labor or material; however, there will be a charge for travel expense at the service center's current rate.

Note Changes in the product not approved in writing by Welch Allyn shall void this warranty. Welch Allyn shall not be responsible for any indirect, special or consequential damages, even if notice has been given in advance of the possibility of such damages.

THIS WARRANTY IS IN LIEU OF ALL OTHER WARRANTIES, EXPRESSED OR IMPLIED, INCLUDING BUT NOT LIMITED TO, ANY IMPLIED WARRANTY OF MERCHANTABILITY OR FITNESS FOR A PARTICULAR PURPOSE.

Appendices

Appendix A: Specifications

Probe specifications

Item	Specification
Measurement type	Distortion Product Otoacoustic Emissions (DPOAE) Transient Evoked Otoacoustic Emissions (TEOAE)
Frequency range	DPOAE: 2.0 to 5.0 kHz TEOAE: 1.5 to 4.0 kHz
Stimulus intensity	DPOAE: 50 to 65 dB SPL TEOAE: 80 dB SPL peak equivalent (± 3 dB)
Microphone system noise	<ul style="list-style-type: none"> -20 dB SPL @ 2 kHz (1 Hz bandwidth) -13 dB SPL @ 1 kHz (1 Hz bandwidth)
Dimensions and weight	<ul style="list-style-type: none"> Length: 40 in. (1.0 meter) Weight: 1.00 oz. (28 gm)
Connector	HDMI

Instrument specifications

Item	Specification
Power supply	Lithium-Ion rechargeable battery
Battery life	15 hours on-time
Dimensions and weight	Instrument Weight: 6.4 oz. (180 gm) Instrument Dimensions: 7 in. x 2.75 in. x 1.25 in. (17.78 cm x 6.98 cm x 3.17 cm)
User interface	<ul style="list-style-type: none"> OLED Display to provide user information and progress of measurement.

Item	Specification
	<ul style="list-style-type: none"> 4-button keypad to control instrument functions
Connectors/Communications	<ul style="list-style-type: none"> Integrated USB communication capability for battery charging and communication with PC-based database programs or an optional PC printer HDMI Connector for connection to the Probe Integrated Wireless Class 2 + EDR with SPP Protocol for communication with printer

Power supply specifications



CAUTION Use only approved power supply. Failure to use the proper power supply may affect the stability of the device.

Item	Specification
Model No.	UES12LCP-050160SPA
Output	5.0V DC, 1.6A
Input	100-240V AC, 50-60Hz, 500 mA

Environmental requirements

Item	Specification
Operating temperature	59°F to 95°F (15°C to 35°C)
Operating relative humidity	30% to 90% (non-condensing)
Maximum operating altitude	6000 feet (2000 meters)
Transport and storage temperature	41°F to 104°F (5°C to 40°C)

Wireless specifications (device)

Category	Feature	Implementation
Wireless specification	Transmit power	Class 2, +3dBm
	Range	30 meters line-of-sight
	Frequency	2.402 to 2.480 GHz
Coexistence	802.11	IEEE 802.11

Category	Feature	Implementation
Antenna	Internal, chip antenna	Max. gain 0.5dBi
Environmental	Operating temperature	-40 °C to +85 °C
	Operating voltage	2.7V to 3.6V
Approvals	FCC/IC/CE/MIC/KC	Qualified

Wireless specifications (printer)

Category	Feature	Implementation
Wireless specification	Transmit power	Class 2, 3.816dBm
	Range	30 meters line-of-sight
	Frequency	2.402 to 2.480 GHz
Coexistence	802.11	IEEE 802.11
Antenna	Internal, chip antenna	Max. gain 1dBi
Environmental	Operating temperature	-20 °C to +70 °C
	Operating voltage	3.3V
Approvals	FCC/IC/CE/MIC/KC	Qualified

This device is a 2.4 GHz wideband transmission system (transceiver), intended for use in all EU member states and EFTA countries, except in **France** and **Italy** where restrictive use applies.

In Italy the end-user should apply for a license at the national spectrum authorities in order to obtain authorization to use the device for setting up outdoor radio links and/or for supplying public access to telecommunications and/or network services.

This device may not be used for setting up outdoor radio links in **France** and in some areas the RF output power may be limited to 10 mW EIRP in the frequency range of 2454 – 2483.5 MHz.

For detailed information, the end-user should contact the national spectrum authority in **France**.

Norway — Do not operate the OAE wireless function in the geographical area within a radius of 20 km from the center of Ny-Ålesund

Appendix B: Flowchart – Measurement

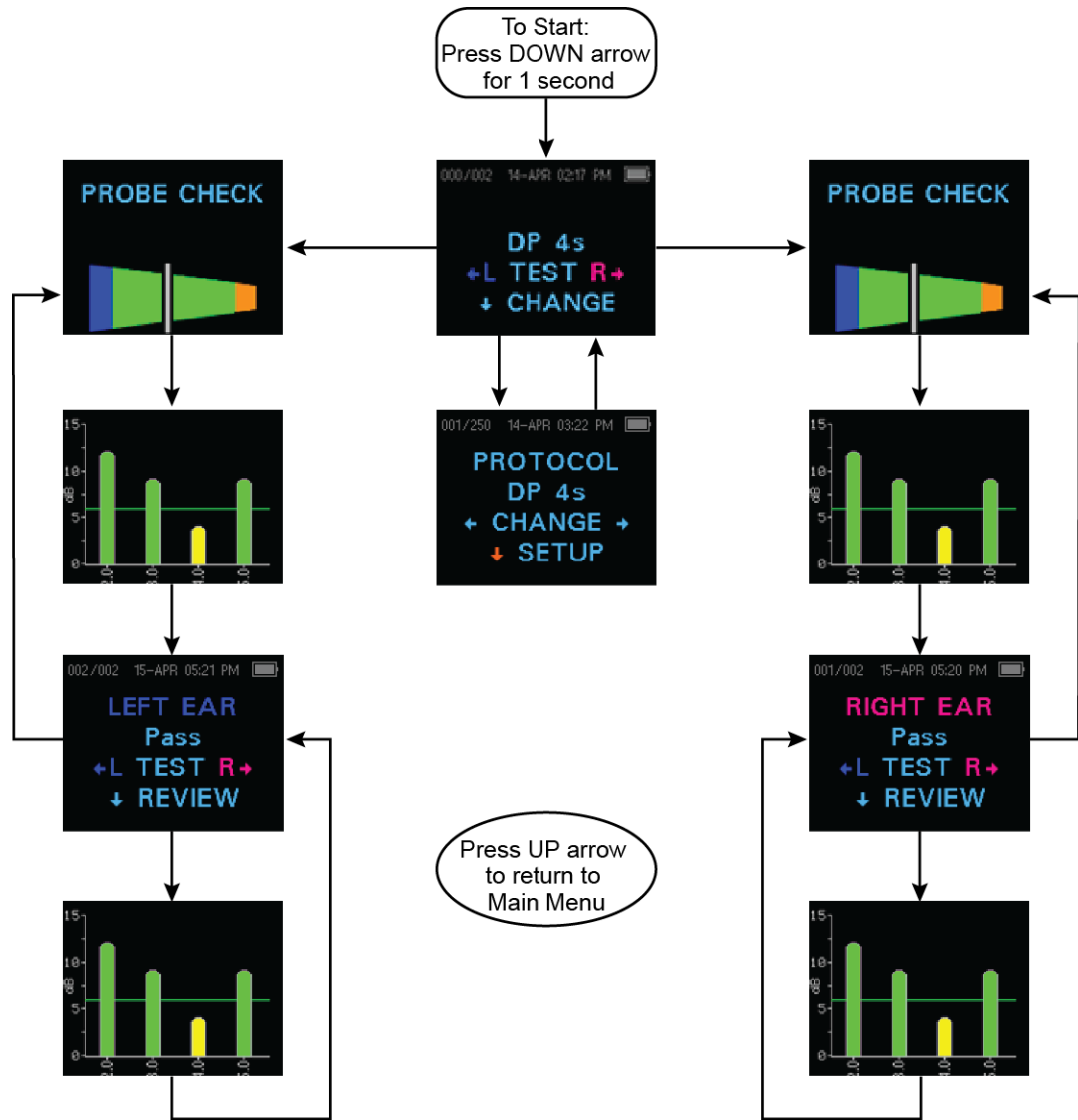

Appendix C: Test sequence

A complete test sequence consists of the following phases:

- AutoStart
- Calibration
- Test

AutoStart phase

The AutoStart phase determines when the calibration phase should proceed. Artifact rejection is employed during the test phase to reduce the effect of transient noise bursts.

Immediately after you press the test button, the AutoStart phase begins. AutoStart checks both the quality and stability of the seal by measuring the response obtained from a sequence of test tones. The stability of the seal is determined by comparing the responses obtained over time. When the level of the response is within an acceptable range and is stable over time, the unit proceeds to the calibration phase.

Calibration phase

DPOAE screener

The calibration phase calibrates the level of the tones that will be applied during the actual test phase. The calibration phase automatically measures the response obtained from a sequence of calibration tones and calculates the voltage needed to obtain the desired intensity levels. If the desired peak pressure cannot be obtained, the unit will use the maximum voltage. A successful calibration leads to the actual test phase.

TEOAE screener

The calibration phase automatically measures the peak pressure obtained from a sequence of clicks and calculates the voltage required to obtain the target peak pressure. If the desired peak pressure cannot be obtained, the unit will use the maximum voltage. A successful calibration leads to the actual test phase.

Test phase

DPOAE screener

The test phase consists of measuring the response obtained from the pairs of test frequencies (f_1 , f_2) applied to the receivers. Two receivers are used, with each receiver generating one frequency in order to reduce intermodulation distortion. Frequency domain estimates of the actual L1, L2, distortion (DP) and noise floor (NF) are obtained via the discrete Fourier Transform, with a bin resolution of approximately 31 Hz. The NF estimate is obtained by averaging the power in the 4 closest (+/-2) bins to the DP bin.

TEOAE screener

The test phase consists of measuring the response obtained from repeated sequences of clicks applied to the receivers. The click sequence is 3-1-1-1 repeated twice. Signal and noise floor estimates are obtained by adding/subtracting the two response sequences, respectively. The energy of the signal and noise floor estimates in various

frequency bands is obtained in real time and displayed once per second. The average peak pressure of the stimulus is calculated after completion of the test.

Artifact rejection is employed during the test phase to reduce the effect of transient noise bursts by the use of an adaptive rejection threshold. The unit attempts to accept the quieter sections of the test, while rejecting the noisier portions of the test. When the noise level is approximately constant during the test, the instrument will tend to accept most of the data in the test. However, as the level of the noise becomes more variable over time, the instrument will attempt to accept the quieter portions of the recording. Noise estimates are obtained approximately 32 times per second and a suitable threshold is estimated from the data. Data segments with a noise floor above this threshold are rejected, which tends to lower the noise floor of the test. In order to reduce the possibility of obtaining an artificially low noise floor, the minimum threshold level is limited.

Variations in the SNR Estimate

Be aware that the SNR estimate has an inherent statistical variation due to the effects of random noise, especially when no emission is actually present. If you perform a test with the instrument's probe placed in a test cavity, theoretically the SNR will be greater than 6 dB approximately 7 times out of 100. This is not a limitation of the instrument, but a fundamental property of the method used to estimate the SNR in all emission testing. In order to reduce the occurrence of this "false" emission, the instrument limits the minimum value of NF, which has the effect of reducing the SNR for tests that have a low noise floor. As the noise level of the test increases, the user will notice that more "false" emissions will appear which is to be expected.

Appendix D: Pass/Refer criteria

DPOAE screener

The decision that a DPOAE exists is based on detecting a signal whose level is significantly above the background noise level. This requires a statistical decision, since the random noise level in the DPOAE filter channel can be expected to exceed the average of the random noise levels in the four adjacent filter channels — used as the reference for comparison — roughly 50% of the time.

Extended measurements of the noise distributions in both the DPOAE filter channel “DP level” and the rms average of the 4 adjacent channels “N level” indicate that the SNR ratio (the difference between DP and N) has a standard deviation of 5.5 dB. This implies a 10% probability of seeing a 7 dB SNR simply from the variability of the noise levels in the 2 filter sets.

Requiring an SNR of 6 dB in three out of four frequencies drops the probability of passing an ear with significant hearing loss to 1% or less.

Note By the binomial distribution, two of three frequencies at >8.4 dB or three of six frequencies at >7 dB should also ensure less than 1% probability of passing a moderately-severe hearing-impaired infant.

Preliminary trials with infants indicate that the tester’s technique is the single most important variable in the pass rate on normal-hearing infants. Some testers pick up the technique (see “Prepare patient for testing”) with only a couple of days’ practice, producing pass rates comparable to those for other DPOAE equipment they have used for months; other testers take longer.

Occasional claims of extraordinarily low probabilities of not detecting an ear with hearing loss appear to be based on poor statistics. As discussed by Gorga (Mayo Clinic Teleconference, 1998), since the incidence of significant hearing loss is roughly 2 per 1,000, verifying 99.7% accuracy would require testing hundreds of thousands of babies with a given system. To demonstrate that only 3 babies out of 1,000 with hearing loss were not detected would require follow-up testing of 500,000 babies. To our knowledge, no one has performed such tests to date.

TEOAE screener

The same basic principles that underlie DPOAE Pass/Fail criteria underlie TEOAE Pass/Fail criteria. In the case of transients, requiring SNR of 4 dB at any three out of the six test frequencies drops the probability of passing an ear with a significant hearing loss to less than 1%.

Note The SNR limits for transients are lower than the corresponding limits for distortion products primarily because the traditional noise calculation used in TEOAE measurements (and in the screener) gives a 3 dB lower SNR than the calculation used for DPOAEs. Without that difference, the numerical SNR value for a PASS with the two methods would be quite similar.

The Welch Allyn OAE screener uses a patented noise-rejection algorithm that permits accurate DPOAE and TEOAE measurements in background noise and babble as high as 55 to 65 dB SPL (A-weighted). Briefly explained, use of available memory in the OAE screener processor permits a post-hoc statistical analysis that identifies those samples

whose retention would improve the overall accuracy. Those samples are included in the final analysis; the noisier samples are rejected.

The improved operation in noise with the new algorithm was so substantial that a complete replica of the original validation tests in "fully impaired ear" cavities was conducted and it was verified that no increase in false negatives (false passes) was introduced. Under no test conditions was any such degradation uncovered.

The artifact rejection can only reject the noisiest samples in a measurement period. If the ambient noise level rises too high (and/or the eartip seal is poor), then all samples will be noisy and accurate measurements will be impossible, in which case the test result will indicate "noisy."

Appendix E: Configurations and test protocols

DPOAE screener

Note The protocols included are DP 4s (default) and DP 2s.

Protocol Name	# of Frequencies	F2 Frequency	L1/L2	Averaging Time (max)	Pass SNR	# Passing Frequency for Test Pass
DP 4s	4	2.0, 3.0, 4.0, 5.0 kHz	65/55	4 seconds	6 dB	3
DP 2s	4		65/55	2 seconds	6 dB	3

Note The DPOAE protocols differ in the amount of averaging time per frequency. The DP 4s protocol is the default. This averaging time is the time the screener uses to render a decision on that frequency. The DP 2s (2 second) protocol uses 2 seconds per frequency and results in faster test times at a minimum of 8 seconds. However, it may increase the false referral rate. The DP 4s (4 second) protocol uses 4 seconds averaging time per frequency and results in slower test time at a minimum of 16 seconds per tes. However, it may reduce the false referral rate.

TEOAE screener

Note The protocols included are TE 64s (default) and TE 32s.

Protocol Name	# of Frequency Bands	Frequency Center Bands	Averaging Time (max)	Pass SNR	# Passing Frequency for Test Pass
DP 4s	6	1.5, 2.0, 2.5, 3.0, 3.5, 4.0 kHz	32 seconds	4 dB	3
DP 2s	6	1.5, 2.0, 2.5, 3.0, 3.5, 4.0 kHz	64 seconds	4 dB	3

Note The TEOAE protocols differ in the maximum amount of averaging time per test. The TE 64s protocol is the default. The test will stop after 64 seconds have elapsed if a pass or refer result is not obtained. The test may complete in only a few seconds in cases where the OAE is robust and noise levels are low. The TE 32s protocol will stop after 32 seconds have elapsed if a pass or refer result is not obtained.

Appendix F: Approved accessories

The following table lists approved accessories for 39500, 39500-NP, 39500-TE and 39500-NP-TE.

Part Number	Description
39402	OAE HEARING SCREENER PROBE ASSEMBLY
39405	OAE HEARING SCREENER POWER SUPPLY
39410	MPT-II PRINTER SET
39412	MPT-II Printer Paper, Single Roll 39413 OAE Hearing Screener Charging Cradle
39416	OAE MPT-II PRINTER LI-ION BATTERY PACK
39407	MPT-II PRINTER POWER SUPPLY
39414	OAE REPLACEMENT USB CABLE
39415	OAE HEARING SCREENER CARRYING CASE
39424	OAE REPLACEMENT MICRO USB CABLE
39420	EAR TIP STARTER KIT
39421	OAE PROBE TUBES; QTY: 100

Appendix G: General radio compliance

The wireless features of this device must be used in strict accordance with the manufacturer's instructions as described in the user documentation that comes with the product.

This device complies with Part 15 of the FCC rules and with the rules of the Canadian ICES-003 as described below.

Federal Communications Commission (FCC)

This device complies with part 15 of the FCC Rules. Operation is subject to the following two conditions:

- This device may not cause harmful interference.
- This device must accept any interference received, including interference that may cause undesired operation.

This equipment has been tested and found to comply with the limits for a Class B digital device, pursuant to Part 15 of FCC Rules. These limits are designed to provide reasonable protection against harmful interference in a residential installation. This equipment generates, uses, and can radiate radio frequency energy. If not installed and used in accordance with the instructions, it may cause harmful interference to radio communications. However, there is no guarantee that interference will not occur in a

particular installation. If this equipment does cause harmful interference to radio or television reception, which can be determined by turning the equipment off and on, the user is encouraged to try and correct the interference by one or more of the following measures:

- Reorient or relocate the receiving antenna
- Increase the distance between the equipment and the receiver
- Consult the dealer or an experienced radio/TV technician for help

Any changes or modifications not expressly approved by the party responsible for compliance could void the user's authority to operate this equipment.

Industry Canada (IC) emissions

This device complies with Industry Canada licence-exempt RSS standard(s). Operation is subject to the following two conditions: (1) this device may not cause interference, and (2) this device must accept any interference, including interference that may cause undesired operation of the device.

Le présent appareil est conforme aux CNR d'Industrie Canada applicables aux appareils radio exempts de licence. L'exploitation est autorisée aux deux conditions suivantes : (1) l'appareil ne doit pas produire de brouillage, et (2) l'utilisateur de l'appareil doit accepter tout brouillage radioélectrique subi, même si le brouillage est susceptible d'en compromettre le fonctionnement.

This radio transmitter (IC ID: 5123A-BGTWT12A) has been approved by Industry Canada to operate with the antenna listed in the specification table.

This Class B digital apparatus complies with Canadian ICES-003.

Cet appareil numérique de la classe B est conforme à la norme NMB-003 du Canada

European Union

Czech	Grason-Stadler tímto prohlašuje, že tento vysílač s nízkým výkonem je v souladu se základními požadavky a dalšími příslušnými ustanoveními směrnice 2014/53/ ES
Danish	Grason-Stadler erklærer herved, at denne lavt strøm transmitter er i overensstemmelse med de væsentlige krav og andre relevante bestemmelser i direktiv 2014/53/EF
Dutch	Hierbij verklaart Grason-Stadler dat deze low power transmitter voldoet aan de essentiële eisen en andere relevante bepalingen van Richtlijn 2014/53/EG
English	Hereby, Grason-Stadler declares that this low power transmitter is in compliance with the essential requirements and other relevant provisions of Directive 2014/53/EC.
Estonian	Käesolevaga Grason-Stadler teatab, et see väikese võimsusega saatja on vastavus olulistele nõuetele ja teistele asjakohastele sätetele direktiivi 2014/53/ EÜ
Finnish	Näin ollen Grason-Stadler vakuuttaa, että tämä pienitehoinen lähetin on direktiivin 2014/53/EY olennaisten vaatimusten ja muiden asiaa koskevien säännösten mukainen
French	Par conséquent, Grason-Stadler déclare que cet émetteur de faible puissance est conforme aux exigences essentielles et autres dispositions pertinentes de la directive 2014/53/CE

German	Hiermit erklärt Grason-Stadler, dass dieser Niedrigleistungssender den grundlegenden Anforderungen und anderen relevanten Bestimmungen der Richtlinie 2014/53/EG entspricht
Greek	Με αυτό τον τρόπο, η Grason-Stadler δηλώνει ότι αυτός ο πομπός χαμηλής ισχύος είναι σύμφωνος με τις βασικές απαιτήσεις και άλλες σχετικές διατάξεις της οδηγίας 2014/53/EK
Hungarian	A Grason-Stadler ezúton kijelenti, hogy ez az alacsony teljesítményű adó megfelel a 2014/53/EK irányelv alapvető követelményeinek és egyéb vonatkozó rendelkezéseinek
Italian	In questo modo, Grason-Stadler dichiara che questo trasmettitore di bassa potenza è conforme ai requisiti essenziali e alle altre pertinenti disposizioni della direttiva 2014/53/CE.
Latvian	Ar šo, Grason-Stadler paziņo, ka šis mazjaudas raidītājs atbilst būtiskajām prasībām un citiem attiecīgiem noteikumiem Direktīvā 2014/53/EK
Lithuanian	Šiuo dokumentu Grason-Stadler deklaruoja, kad šis mažas energijos siųstuvas atitinka esminius reikalavimus ir kitas susijusias nuostatas Direktyva 2014/53/EB
Malti	Hawnhekk, Grason-Stadler jiddikjara li din trasmettitur enerġija baxxa hija konformi mar-reqwiziti essenzjali u dispozizzjonijiet rilevanti ohra tad-Direttiva 2014/53/KE
Polish	Niniejszym Grason-Stadler oświadcza, że ten nadajnik o małej mocy jest zgodny z zasadniczymi wymaganiami i innymi istotnymi przepisami dyrektywy 2014/53/WE
Portuguese	Por este motivo, a Grason-Stadler declara que este transmissor de baixa potência está em conformidade com os requisitos essenciais e outras disposições relevantes da Diretiva 2014/53/CE
Slovak	Grason-Stadler týmto vyhlasuje, že tento vysieláč s nízkym výkonom je v súlade so základnými požiadavkami a ďalšími príslušnými ustanoveniami smernice 2014/53/ES
Slovene	S tem, Grason-Stadler izjavlja, da je ta nizka moč oddajnik v skladu z bistvenimi zahtevami in drugimi ustreznimi določbami Direktive 2014/53/ES
Spanish	Por este medio, Grason-Stadler declara que este transmisor de baja potencia cumple con los requisitos esenciales y otras disposiciones pertinentes de la Directiva 2014/53/EC
Swedish	Grason-Stadler förklarar härigenom att denna låg effekt sändare överensstämmer med de väsentliga kraven och andra relevanta bestämmelser i direktiv 2014/53/EG

This product can be used with the following restriction(s):

France — Outdoor use is limited to 10mW EIRP within the band 2454 to 2483.5MHz.

Norway — Does not apply for the geographical area within a radius of 20km from the center of Ny-Ålesund.

Effective Isotropic Radiated Power (EIRP)

International radio compliance – OAE device

Country	Agency	Information
Mexico	Mexico Instituto Federal de Telecomunicaciones (Federal Telecommunications Institute—IFETEL)	This product contains an Approved module, Model No WT12A, IFETEL No. RCPBLWT17-1489
United Arab Emirates		TRA registered No.: ER56177/17, TRA dealer No.: DA44647/15

Country	Agency	Information
South Africa	ICASA	2018/620

International radio compliance – Thermal printer

Country	Agency	Information
United Arab Emirates		TRA registered No.: ER67618/18, TRA dealer No.: DA44647/15

